

VELTEKO

Vertical packaging
machine

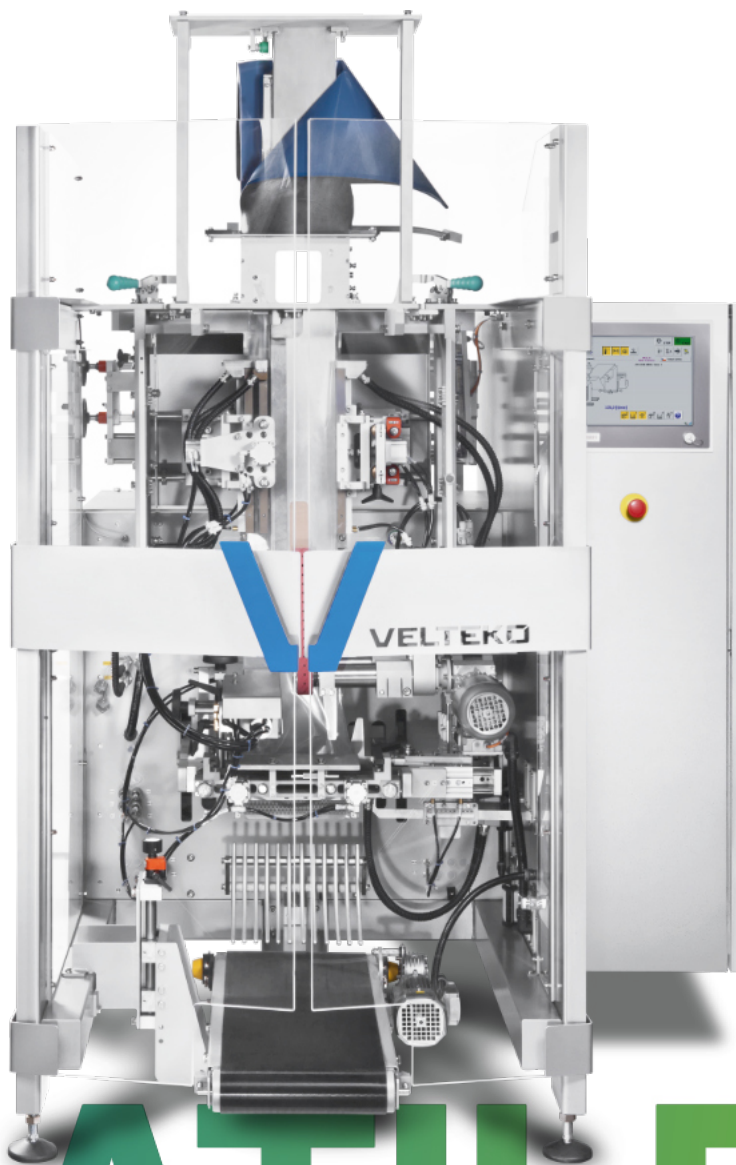

VERSATILE-280

The versatility of VELTEKO vertical packaging machines allows you to customize your machine to meet the current needs of the market and your individual technical requirements.

VERSATILITY

ONE MACHINE FOR YOUR CURRENT AND FUTURE REQUIREMENTS



Maximum speed of
200
bags/min

1 machine
for more than
100 different
variations of bags

5-45 min.
changeovers to
a different bag type



Ease
of operation

VELTEKO
Dataservice
Remote communication
with your machine

Easy
to maintain

1 machine for more than 100 different bag variations

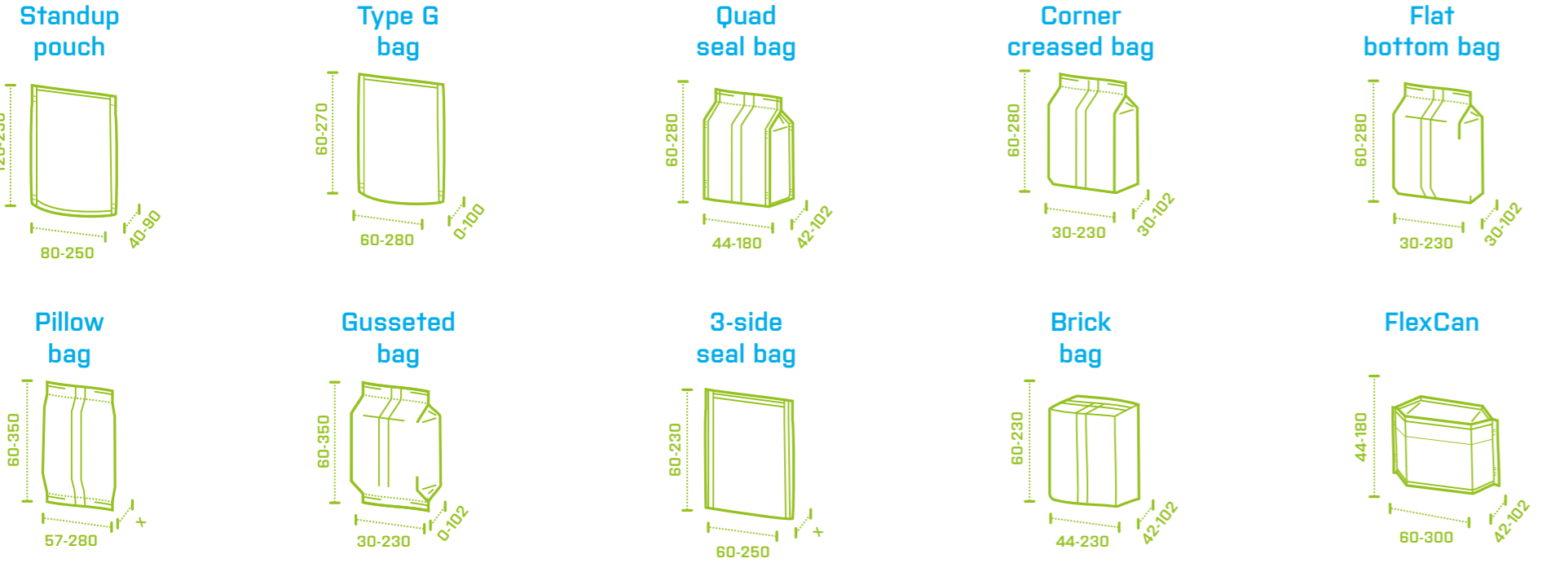

Dimensions stated above are in mm.



Wide range of modifications that extend the function of bags



TOP variations of standup pouches continuously created on 1 vertical packaging machine

Standup pouch with euroslot

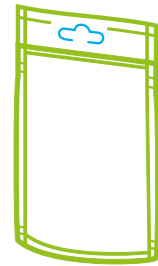

Standup pouch with carry handle

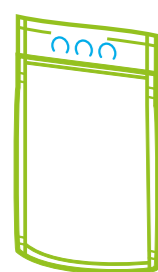

Standup pouch with reclosable flap

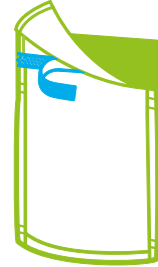

Standup pouch with zipper

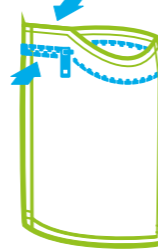

Standup pouch with zipper and euroslot

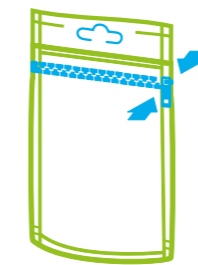

Standup pouch with zipper and carry handle

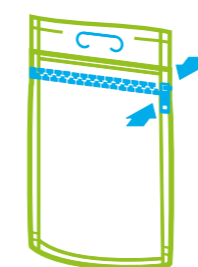

STREAMLINE ULTRASONIC TECHNOLOGY

VELTEKO's „Streamline ultrasonic technology“ is an innovative solution for the ultrasonic sealing of the longitudinal edges of standup pouches and bags with sealed edges. It's the ideal solution for packaging large pieced and fragile products.

Benefits

- Maximum forming tube throughput - edges are formed on circular or oval filling tubes
- Min. risk of damaging fragile products - same drop height as machinery that produces pillow bags
- Extremely attractive bags due to high quality seals
- Maximum speed of 110 bags a minute
- One STREAMLINE device for multiple filling tubes
- No increase in machine footprint
- Energy efficient

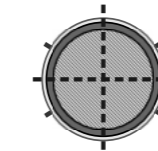

Maximum forming tube throughput

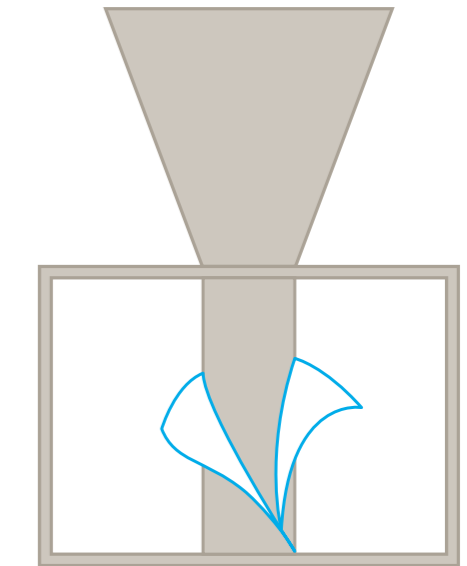

Minimal drop height

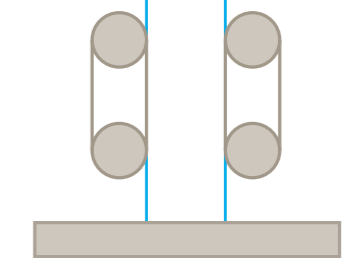

110 bags/min

Ease of operation

VT+ Modules (Versatile Technology Plus)

VT+modules simplify format changing thus reducing machine changeover time and the demands on operator skills.



1.

Dials and Scale Indicators

All manual equipment is equipped with dials or scale indicators to ensure consistent settings.

3.

Position of foil edge sensor and photo cell

Position adjustable by servomotor.

Position setting can be saved to memory.



2.

Unwinding packaging film roll

Automatically regulates the operating parameters of the machine when unwinding film rolls.

4.

Positions of film rollers

For location of print data (label) and for adjusting the entrance angle of the film on the collar.

Digitally monitored.

Position setting can be saved as a program.



Human-machine interface

for intuitive setting of the machine's operational parameters

- A powerful industrial PC with a large color touch screen.
- Customizable control via icons or buttons with text descriptions.
- Assistance in choosing operating parameters.
- 500 memory settings for operating parameters (programs) with export and backup.
- Possibility of automatic selection of programs by scanning a barcode.
- Identification of the machine operator via card or RFID chip.
- User manual, wiring diagram, etc. can be accessed on the terminal's touch screen.
- Image Manager - Import, export, and delete images via the terminal and even capture images from the system's camera.
- Video Manager – Upload and playback of videos.
- Extensive help section.
- Dataservice Visual.



VELTEKO Dataservice

Various data generated during machine operation is recorded and saved. VELTEKO dataservice enables this data to be used e.g. for production control and management and/or for machine diagnostics.

3 packs

Dataservice Support

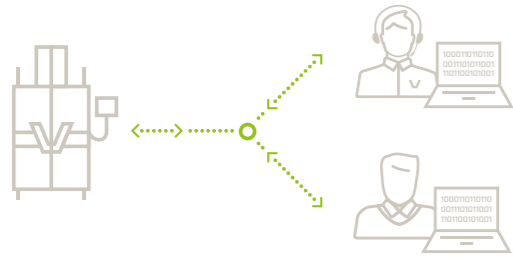

For remote communication between the machine and the user and/or between the machine and the VELTEKO Service Department.

- USB and LAN ports
- VPN router for a secure connection
- Optional IP Service Camera for online transmission of video and audio

Dataservice Visual



Full monitoring of machine use and its technical status from any place in the world that has access to the internet. Dataservice Visual comes as standard equipment on VELTEKO machines.

Dataservice OPC



A versatile software tool that makes all machine data available for any evaluation system.

Easy to maintain

- Dataservice support.
- Monitoring of service intervals, depending on the type of machine operation.
- Extensive self-diagnostics and monitoring.
- Ability to set access rights to individual controls.
- Sensors with connectors for easy replacement.
- Interactive manual and spare parts catalog for each specific machine configuration.
- Automatic check for pneumatic leaks.
- Support from VELTEKO's Service Center.

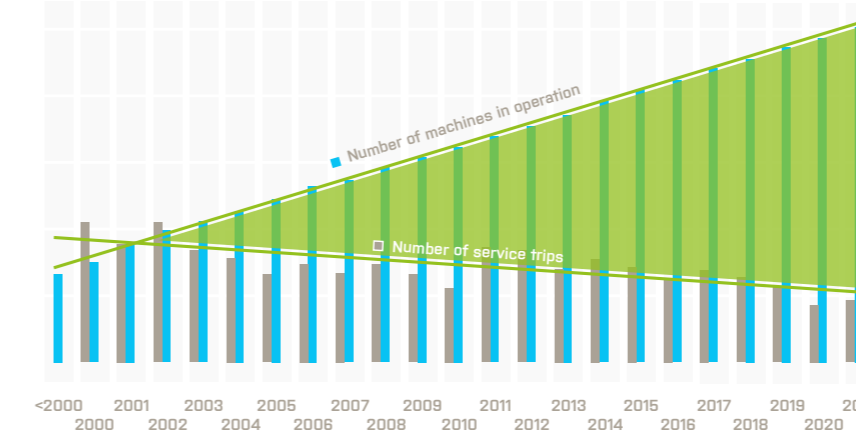

Technical parameters

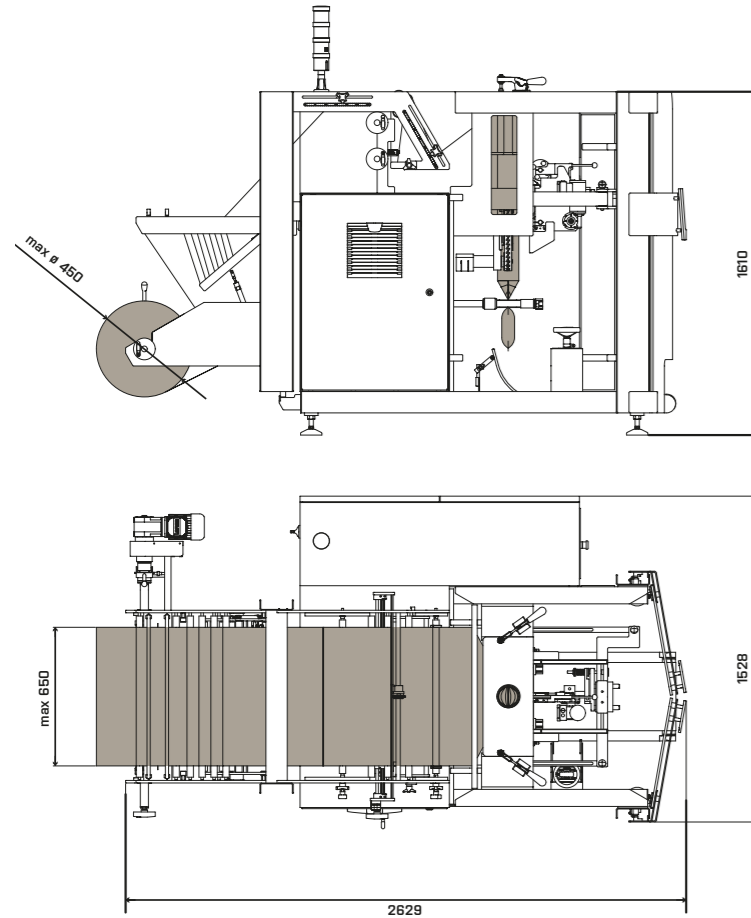

	VERSATILE-280-B STEP	VERSATILE-280-B CONTI
Operating mode	Intermittent	Continuous
Max. practical speed	120 bags/min	200 bags/min
Max. dimension of cross seal	280mm	
Protection	IP54	
Construction materials	Stainless steel / Painted execution	

VELTEKO Philosophy

Provide customers around the world with a wide range of versatile and specialized vertical packaging solutions tailored to their individual needs.

Advanced Engineering, Design and Construction

Extreme reliability and an extra long service life are a direct result of VELTEKO's cutting edge engineering and design, combined with precise manufacturing in the Czech Republic using the highest quality materials and branded components.

We supply complete packaging systems

- ▣ Upstream and downstream systems
- ▣ Custom project engineering
- ▣ Technical and engineering support throughout the packaging system's life cycle

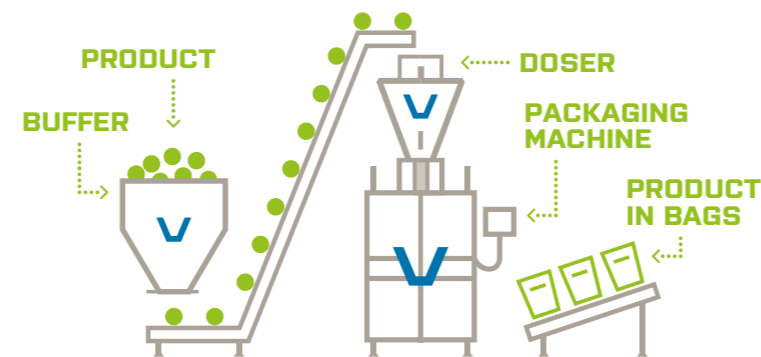

Contacts

VELTEKO CZ s.r.o.
K Borovickam 1716
258 01 Vlasim
Czech Republic
Tel. +420 317 846 473
velteko@velteko.cz

VELTEKO POLSKA Sp. z o. o.
Ul. Sw. Michala 43
61-119 Poznań
Polska
Tel. + 48 61 650 34 07
velteko@velteko.pl

GLOBAL SALES NETWORK

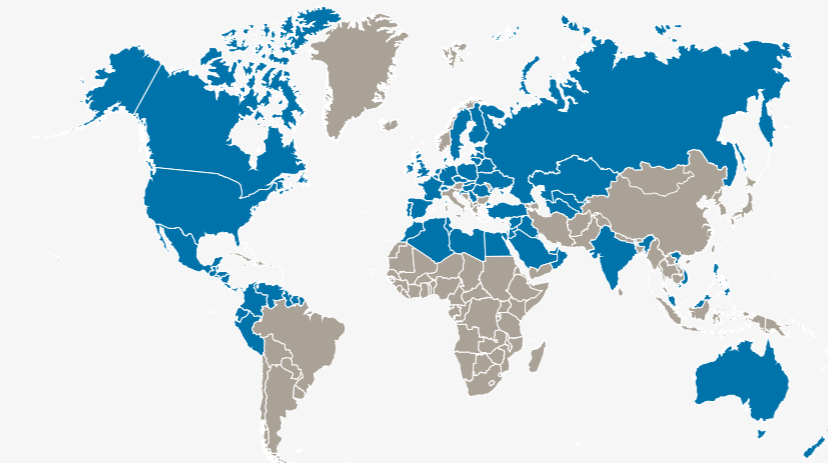

REGIONS COVERED BY VELTEKO DISTRIBUTORS

Your VELTEKO Distributor



www.velteko.com

The contents of this catalog are not an offer for a contract, a promise to conclude a contract nor any legal proceedings by VELTEKO s.r.o. regardless of its content or denominations. VELTEKO s.r.o. reserves the right to change the specifications of machines that are illustrated and described in this catalog. Photos of machines are for informational purposes only and may contain optional accessories. Please contact your local distributor to receive an offer that is tailored to your requirements.

More machines from our portfolio

US-100

- ▣ Up to 120 different bag types
- ▣ Tin Tie reclosing system
- ▣ Packaging of fragile products
- ▣ Custom product mixes



DUPLEX-360

- ▣ Maximum speed of 360 pillow or three-side sealed bags per minute
- ▣ Double tube design



VELTEKO – The vertical packaging machine experts